

# RDC4021-DY 40 characters x 2 lines + yellow green led backlight, 4/8-bit parallel, 5V

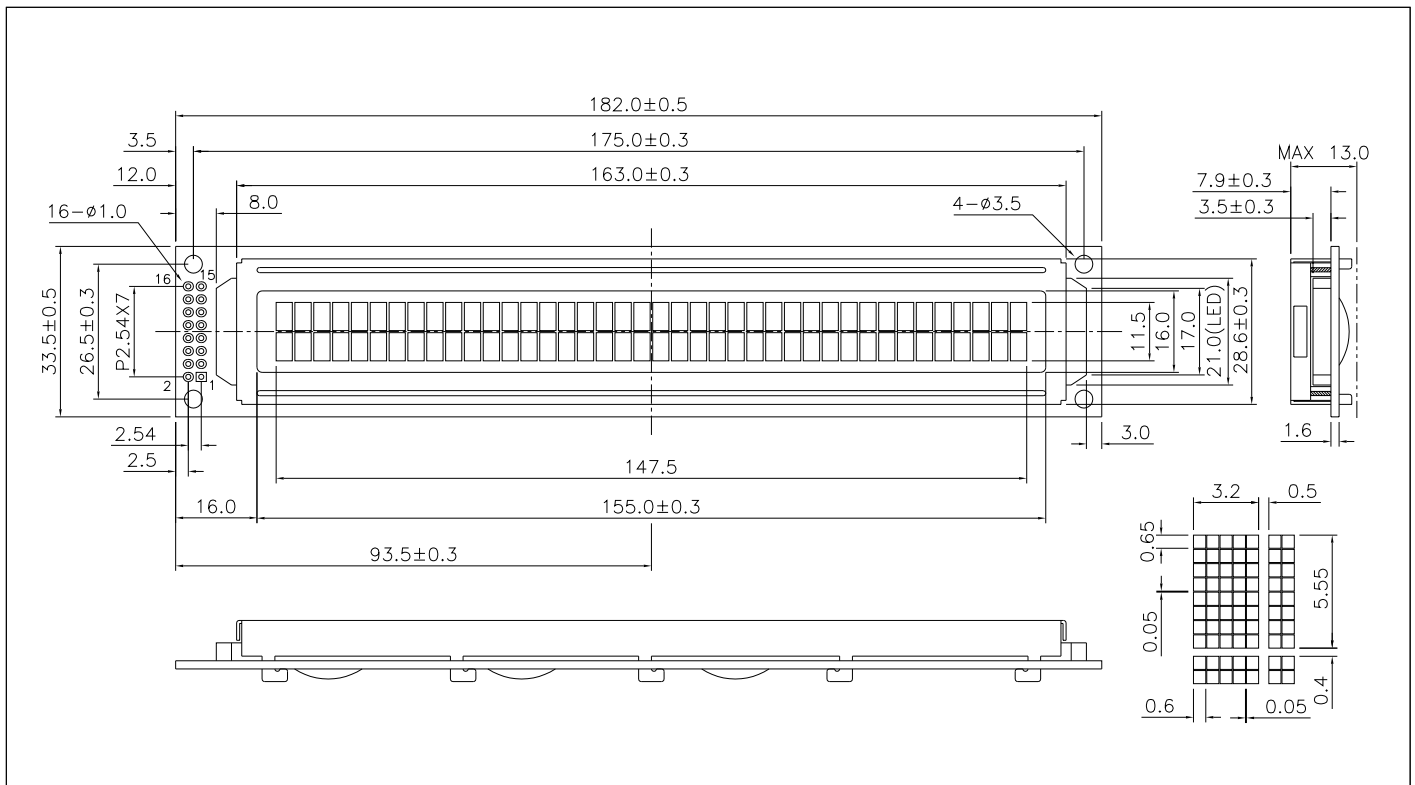

## ABSOLUTE MAXIMUM RATINGS

Item	Symbol	Min.	Max.	Unit
Supply Voltage(Logic)	$V_{DD} - V_{SS}$	-0.3	7.0	V
Supply Voltage(LCD)	$V_{DD} - V_o$	-0.3	10.0	V
Input Voltage	$V_i$	-0.3	$V_{DD} + 0.3$	V
Operating Temp.	$T_{opr}$	-20	70	°C
Storage Temp.	$T_{stg}$	-30	80	°C

## MECHANICAL DATA

Item	Nominal Dimensions	Unit
Module Size ( W x H x T )	182.0 x 33.5 x 13.0	mm
Viewing Area ( W x H )	155.0 x 16.0	mm
Character Size ( W x H )	3.2 x 5.55	mm
Dot Size ( W x H )	0.6 x 0.65	mm
Weight	Approx. 85	g

## ELECTRICAL CHARACTERISTICS ( $V_{DD}=5V\pm0.25V$ )

Item	Symbol	Test Condition	Min.	Typ.	Max.	Unit
Input High Voltage	$V_{IH}$	--	2.5	--	$V_{DD}$	V
Input Low Voltage	$V_{IL}$	--	-0.3	--	0.6	V
Output High Voltage	$V_{OH}$	$I_{OH} = -0.1mA$	2.4	--	$V_{DD}$	V
Output Low Voltage	$V_{OL}$	$I_{OL} = 0.1mA$	0	--	0.4	V
Supply Current	$I_{DD}$	$V_{DD} = 5.0V$	--	2.0	5.0	mA
LCD Driving Voltage	$V_{DD} - V_o$	$T_a=25^\circ C$	--	4.6	--	V

## PIN CONNECTIONS

Pin	Symbol	Level	Function
1	$V_{SS}$	0V	GND
2	$V_{DD}$	5V	Power supply for logic
3	$V_o$	--	Operating voltage for LCD
4	RS	H/L	H : Data L : Instruction code
5	R/W	H/L	H : Read L : Write
6	E	H,H>L	Enable signal Read data when E is high Write data at falling edge of E
7	DB0	H/L	In 8-bit bus mode, used as low order bidirectional data bus. In 4-bit bus mode, open these pins.
8	DB1	H/L	
9	DB2	H/L	
10	DB3	H/L	
11	DB4	H/L	In 8-bit bus mode, used as high order bidirectional data bus.
12	DB5	H/L	
13	DB6	H/L	In 4-bit bus mode, used as both high and low order data bus.
14	DB7	H/L	
15	LEDA	5V	Power supply for LED backlight
16	LEDK	0V	

## BLOCK DIAGRAM

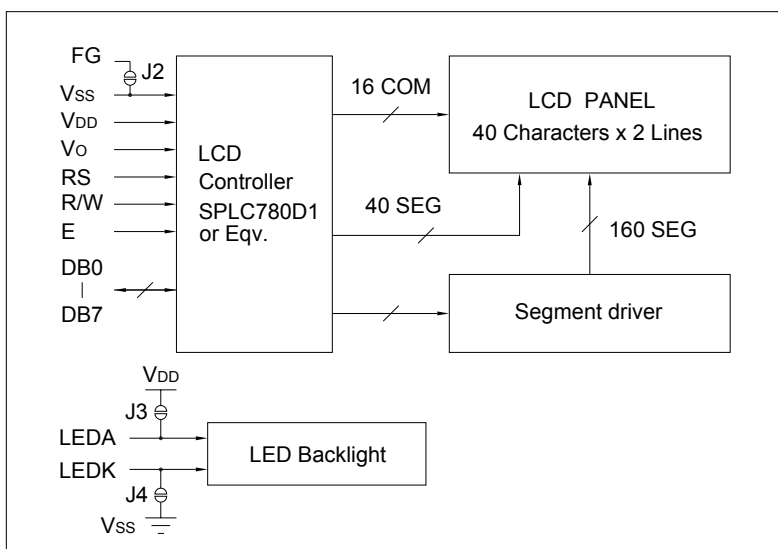

## LED BACKLIGHT SPECIFICATIONS ( $T_a=25^\circ C$ )

Item	Symbol	Typ.	Max.	Unit
Forward Voltage	$V_f$	2.8	3.0	V
Forward Current	$I_f$	20	--	mA
LED Color		Yellow Green		